

Colmo centrale / Central ridge

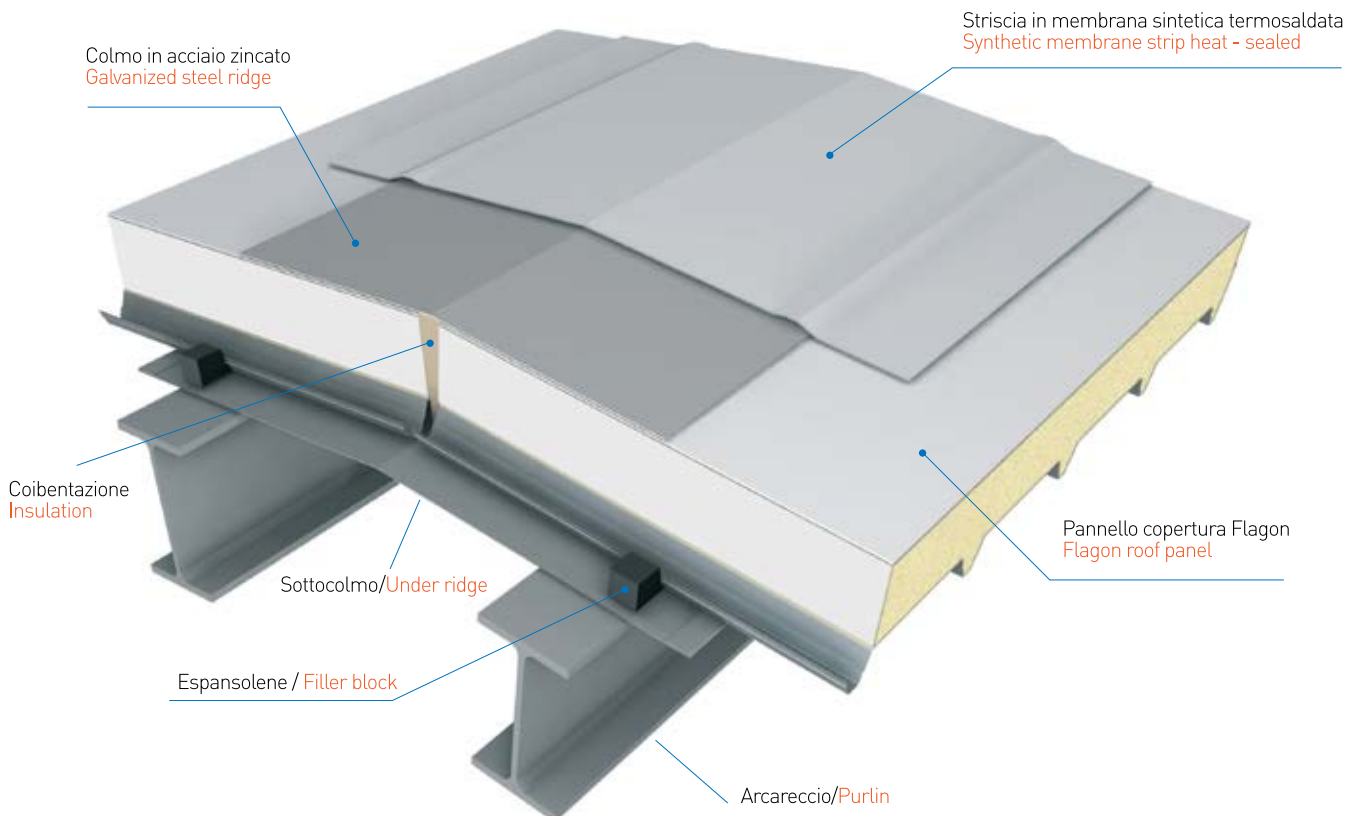

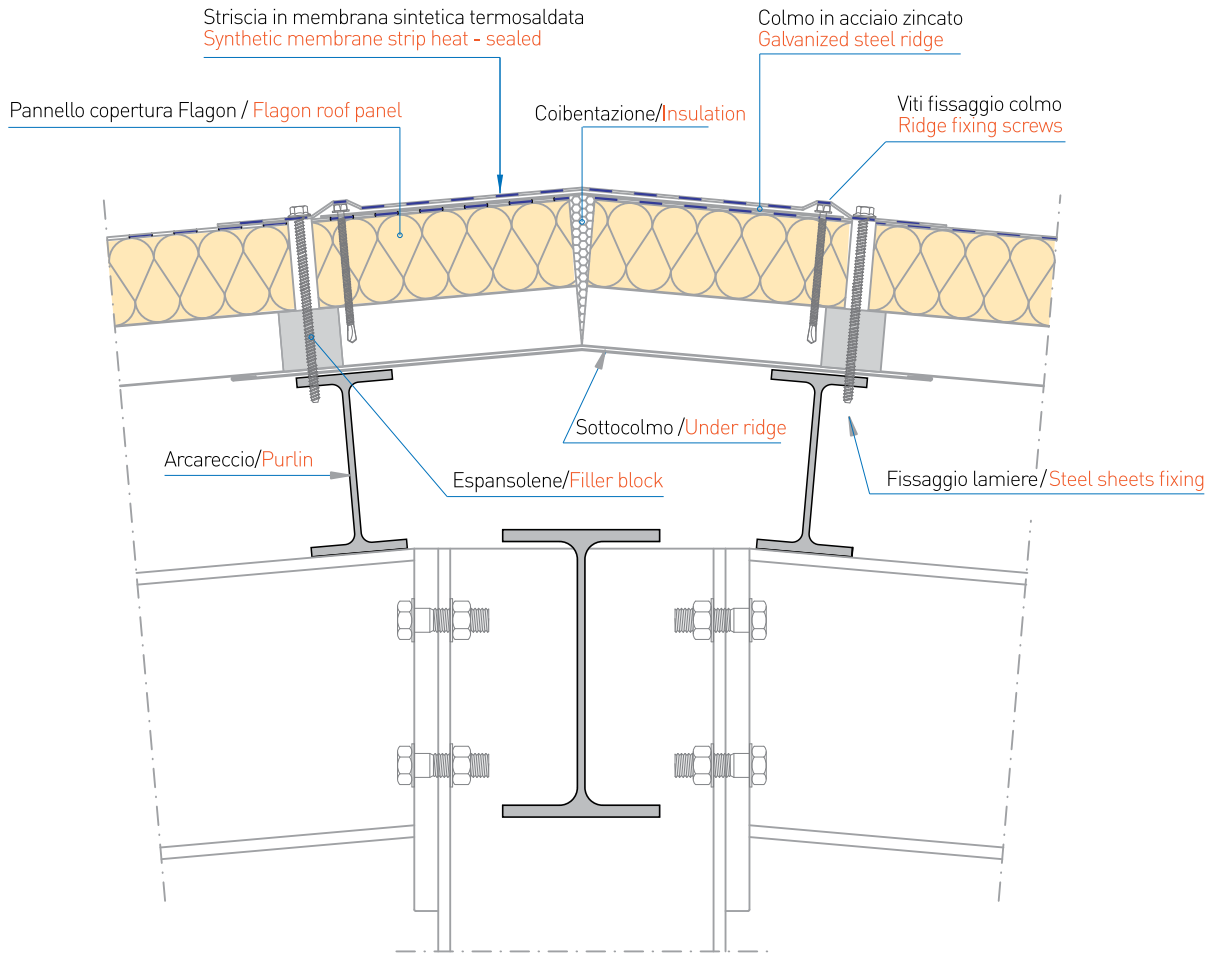
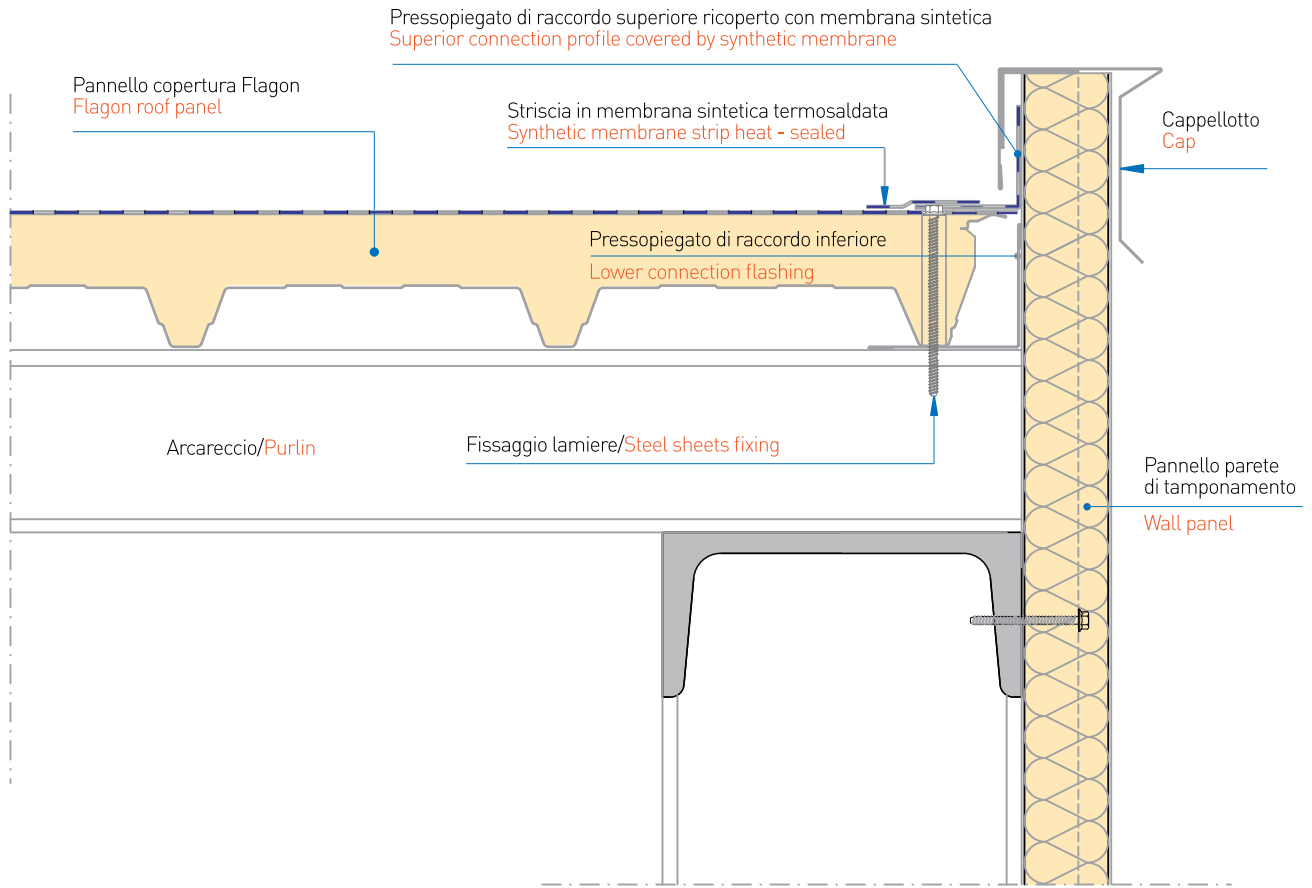

Raccordo parete/Wall-Roof connection

Sezione longitudinale/Longitudinal section

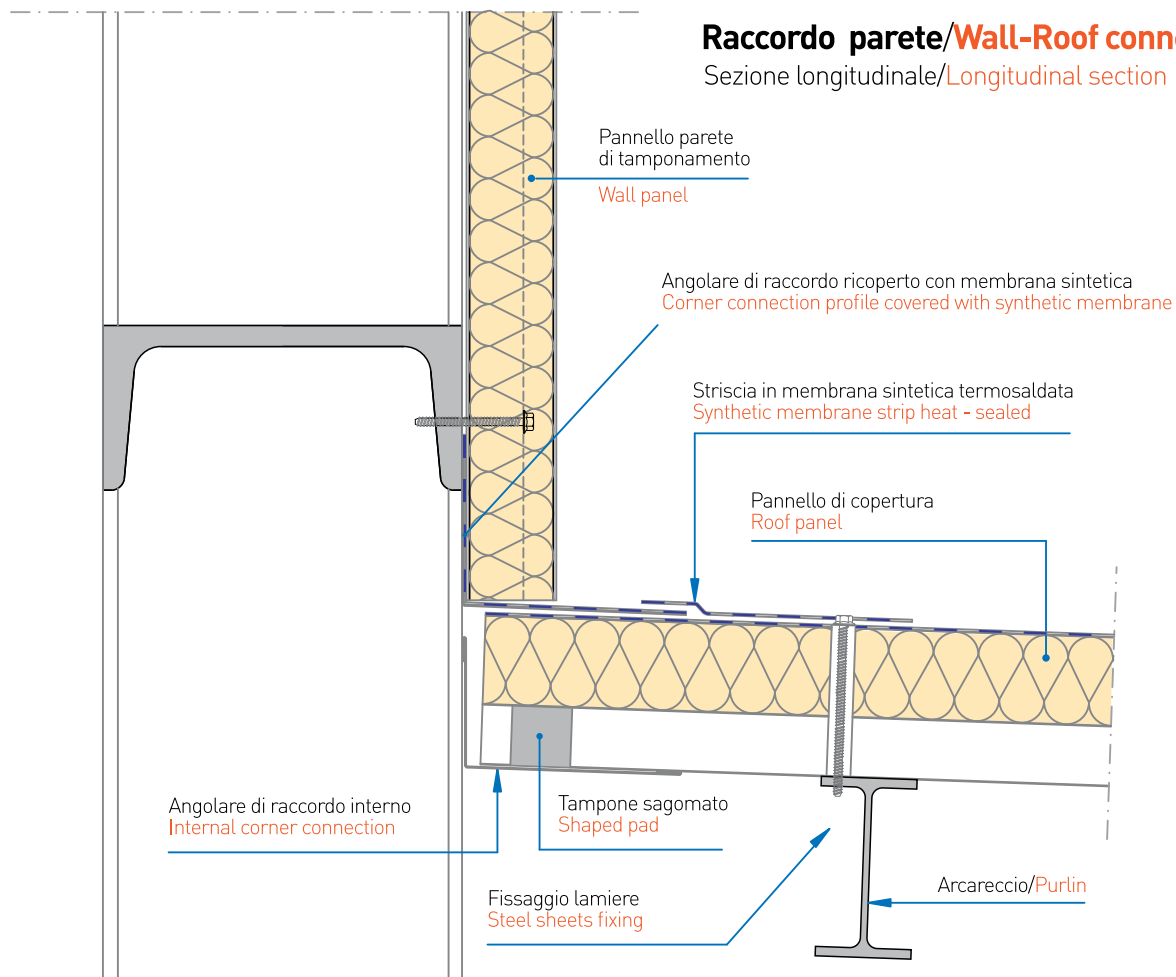

Raccordo parete/Wall-Roof connection

Sezione longitudinale/Longitudinal section

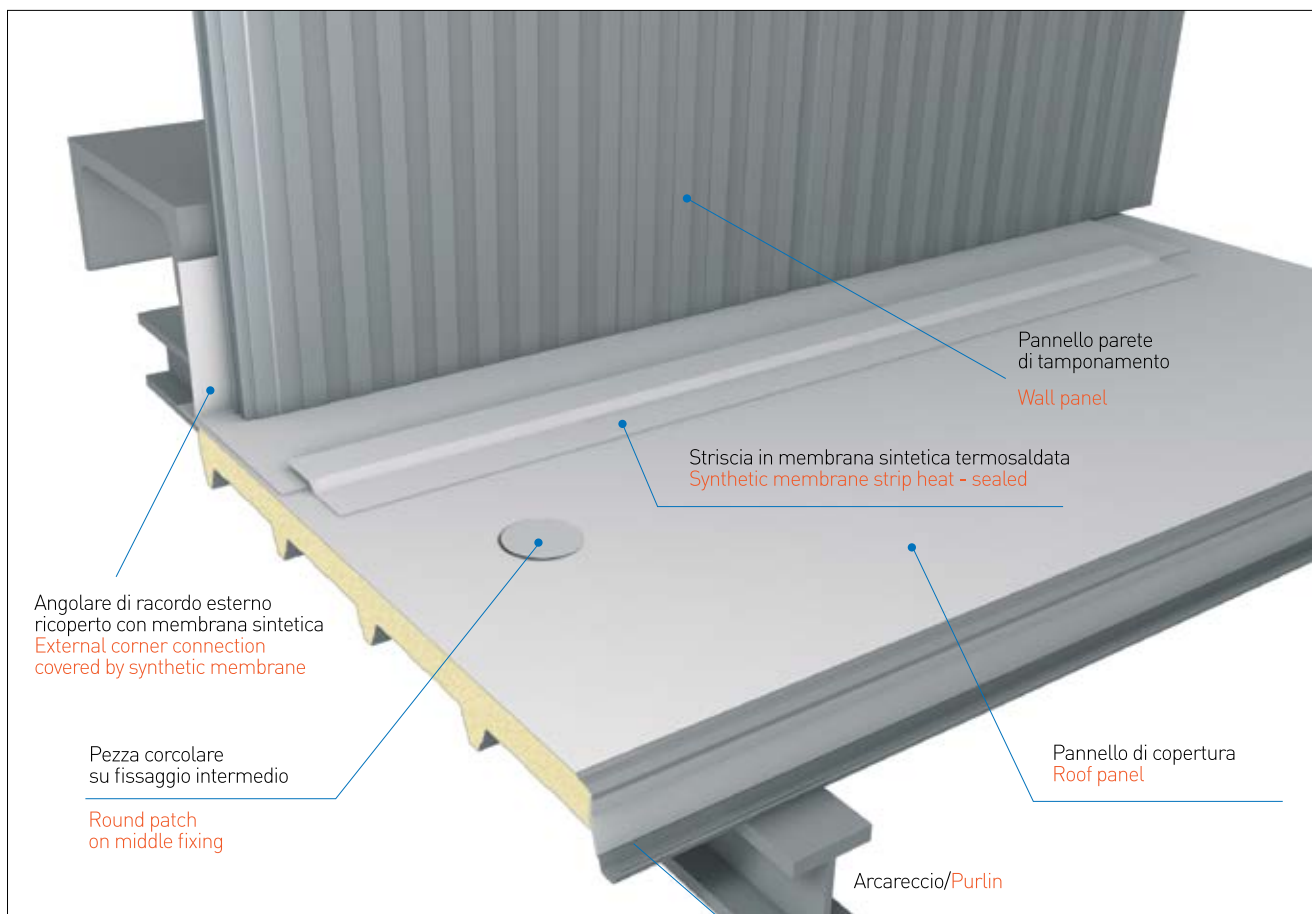
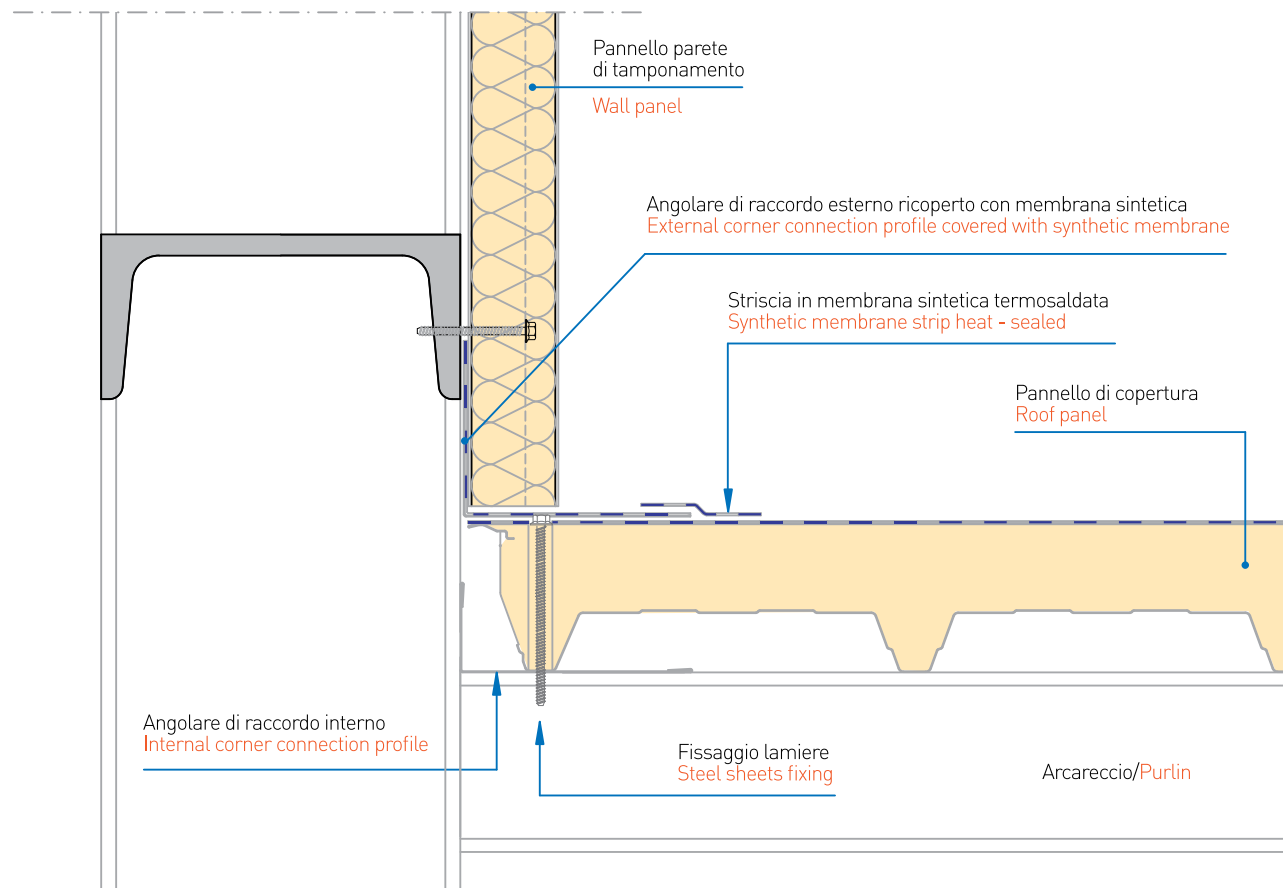

Raccordo parete - copertura 2 / Wall - roof connection 2

Sezione longitudinale / Longitudinal section

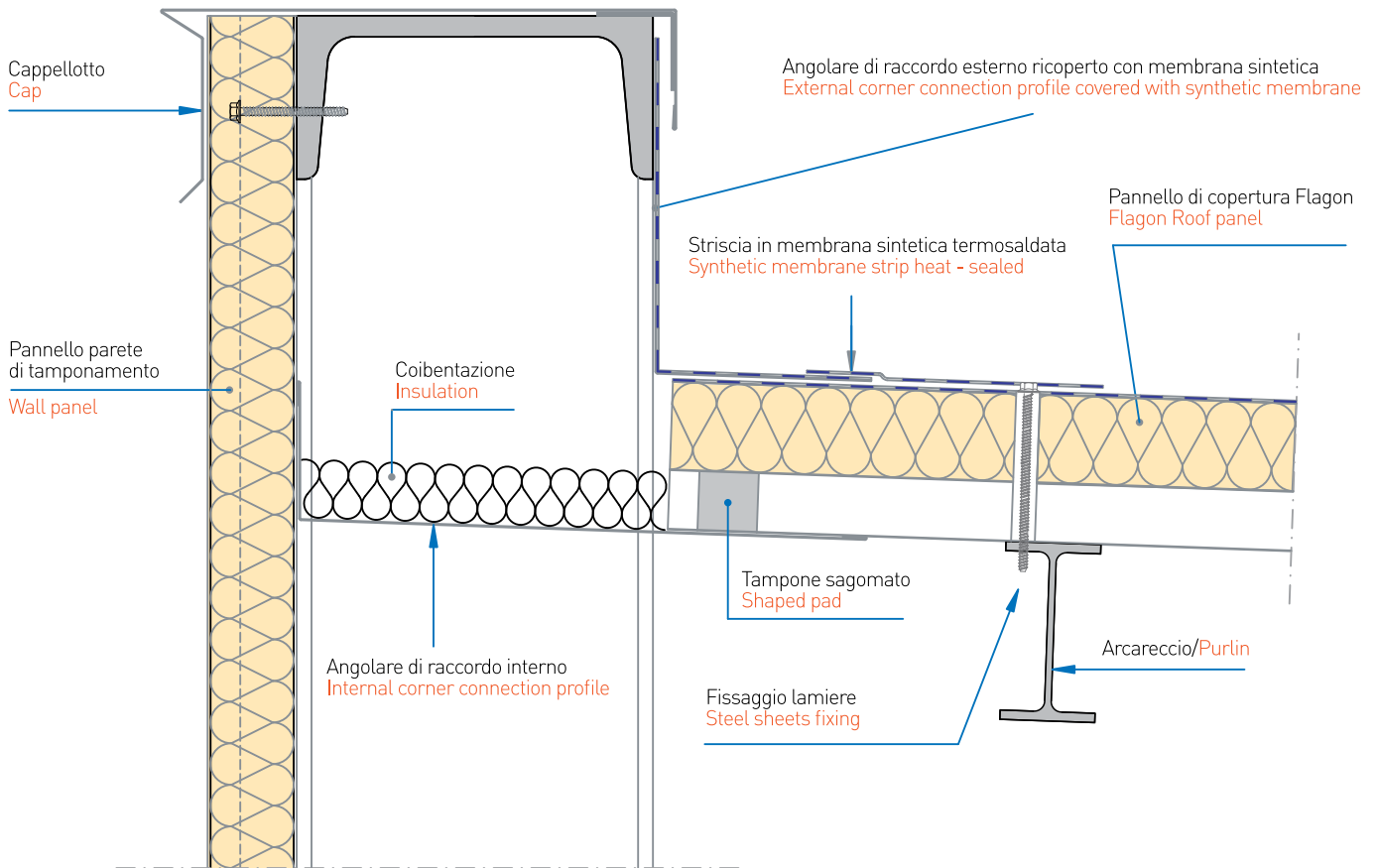

Raccordo parete - copertura 2 / Wall - roof connection 2

Sezione trasversale / Cross section

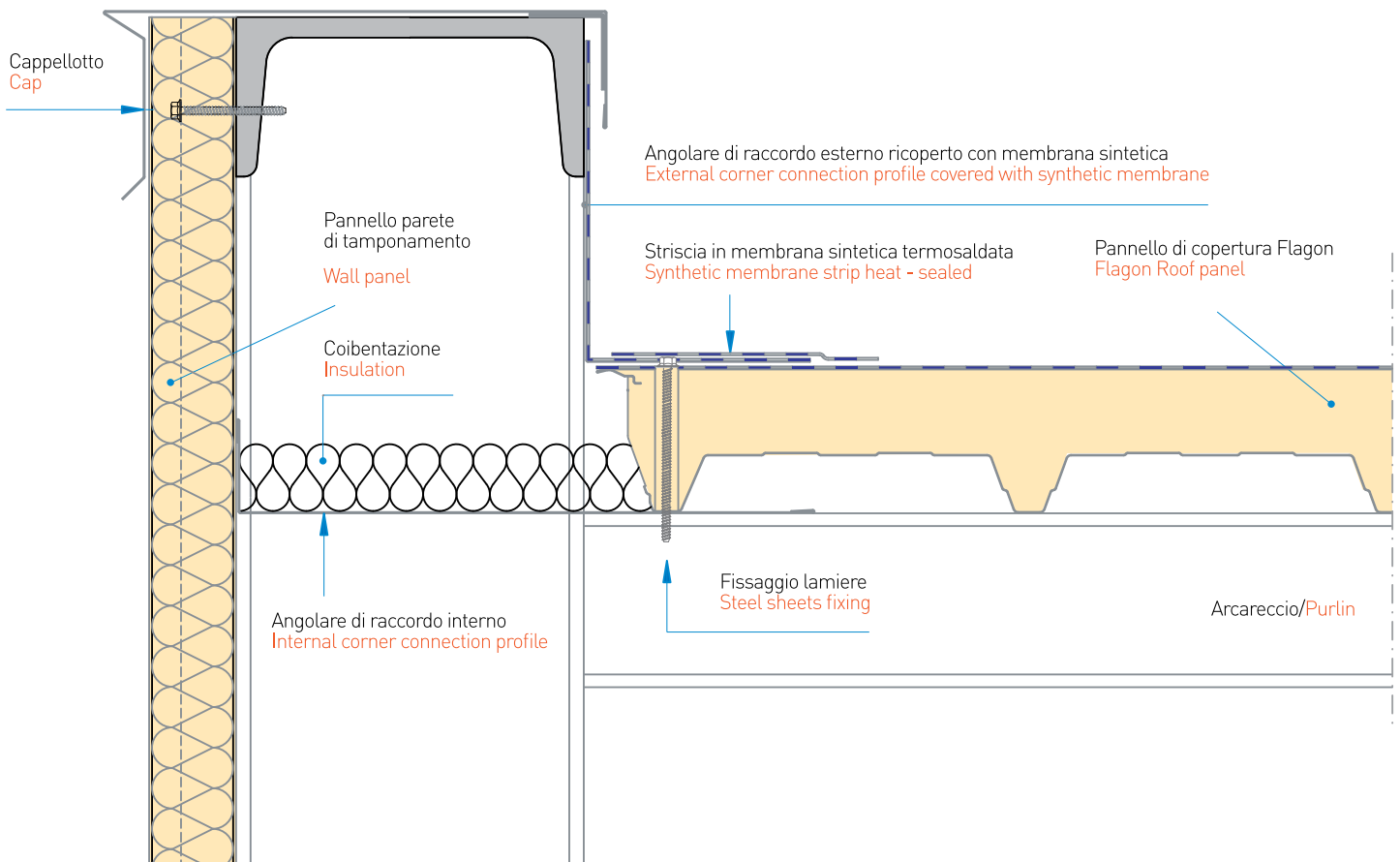

Conversa centrale/Central converse

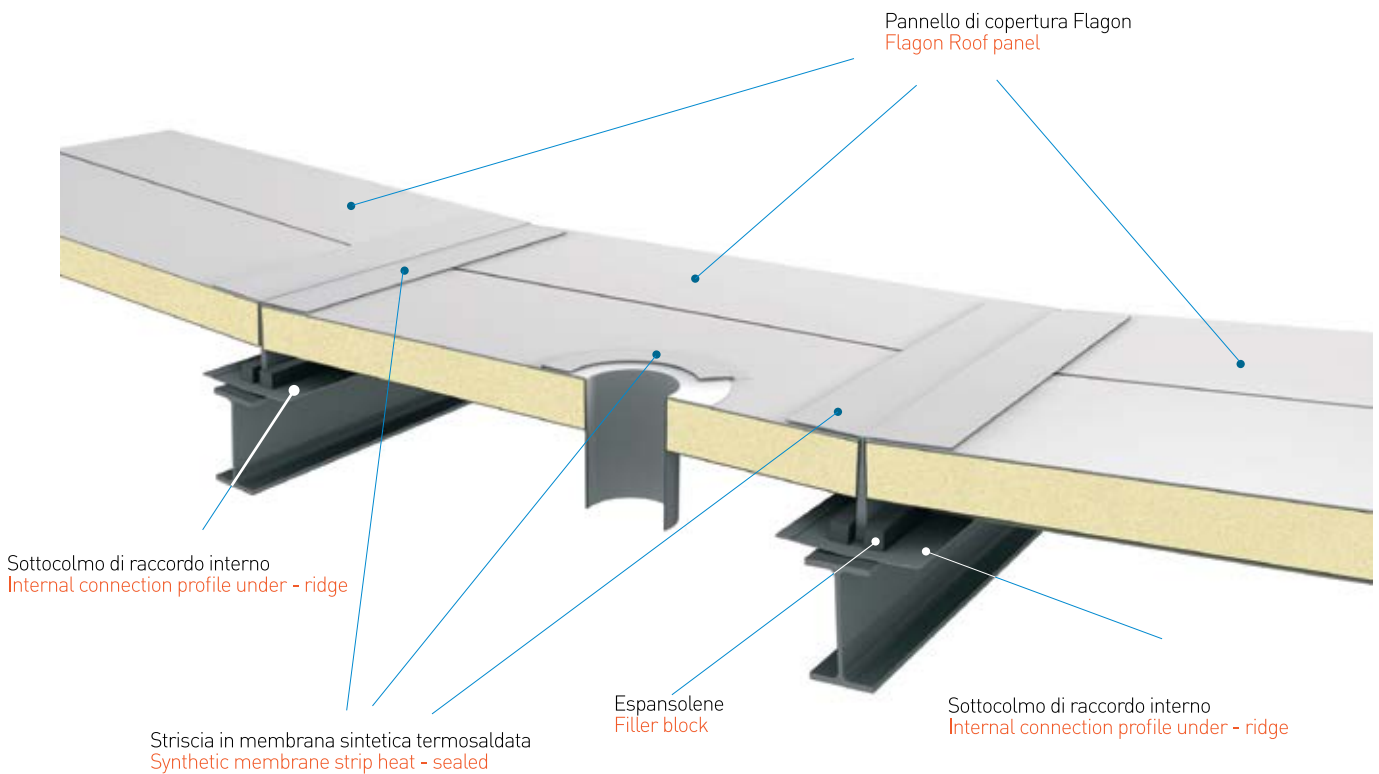
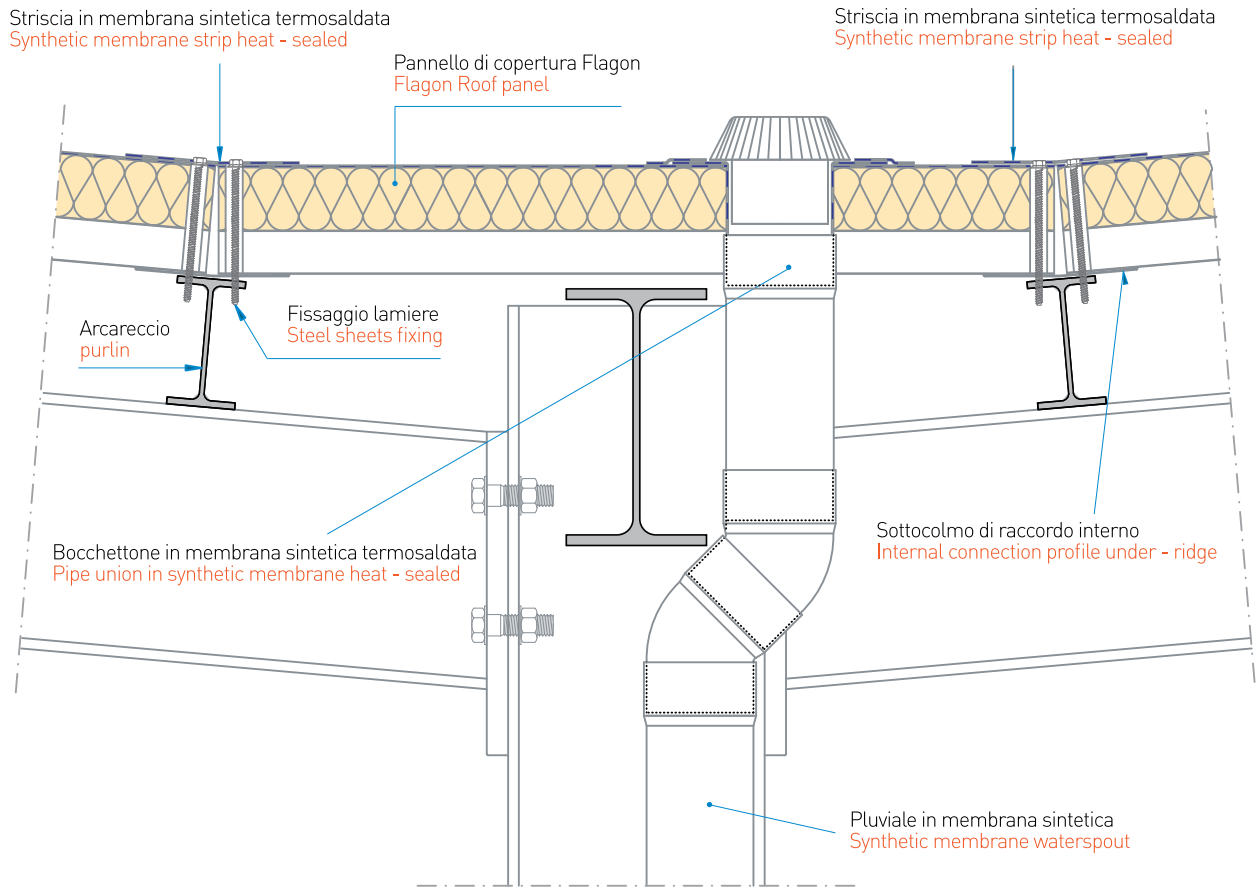

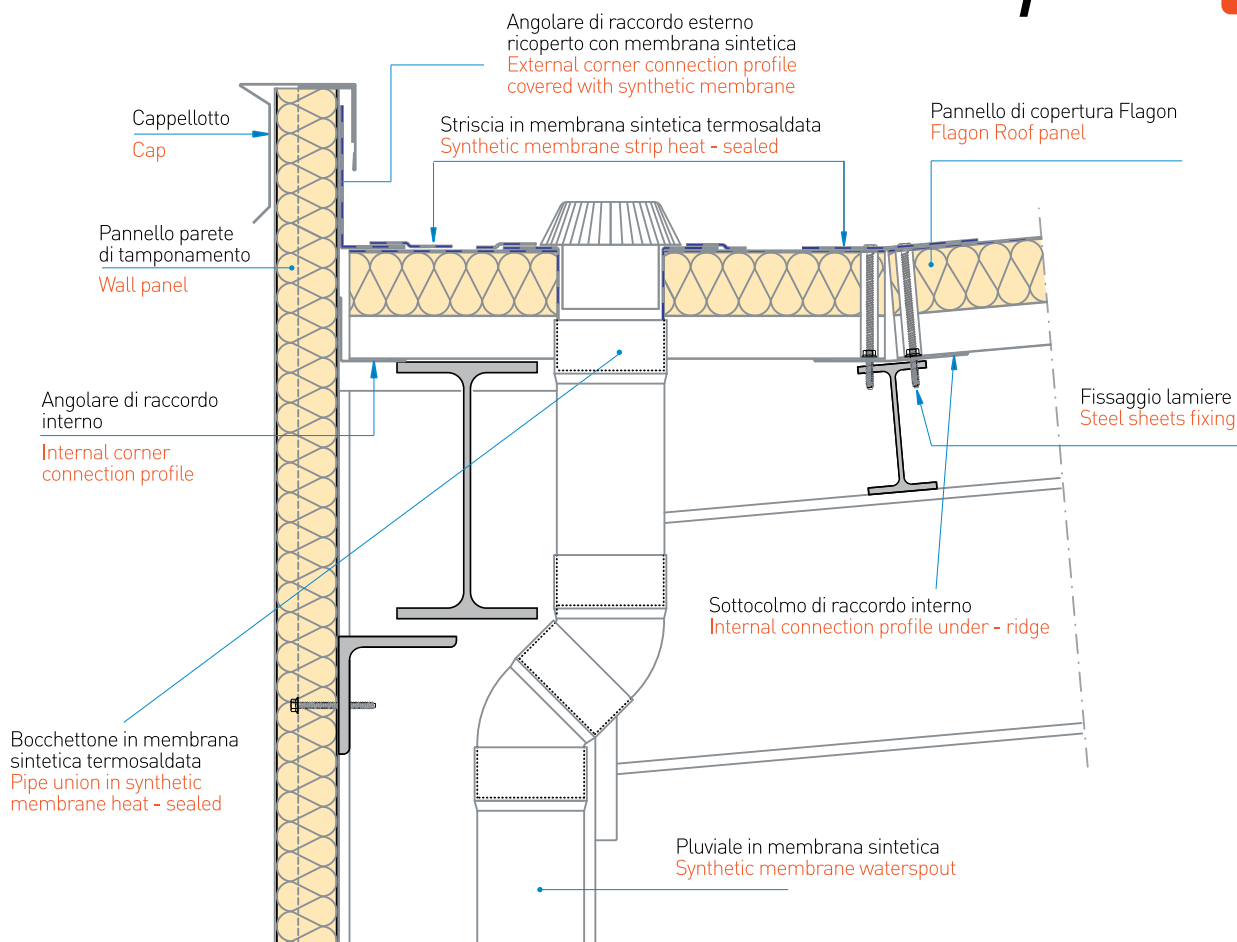

Gronda laterale coibentata/Insulated lateral gutter

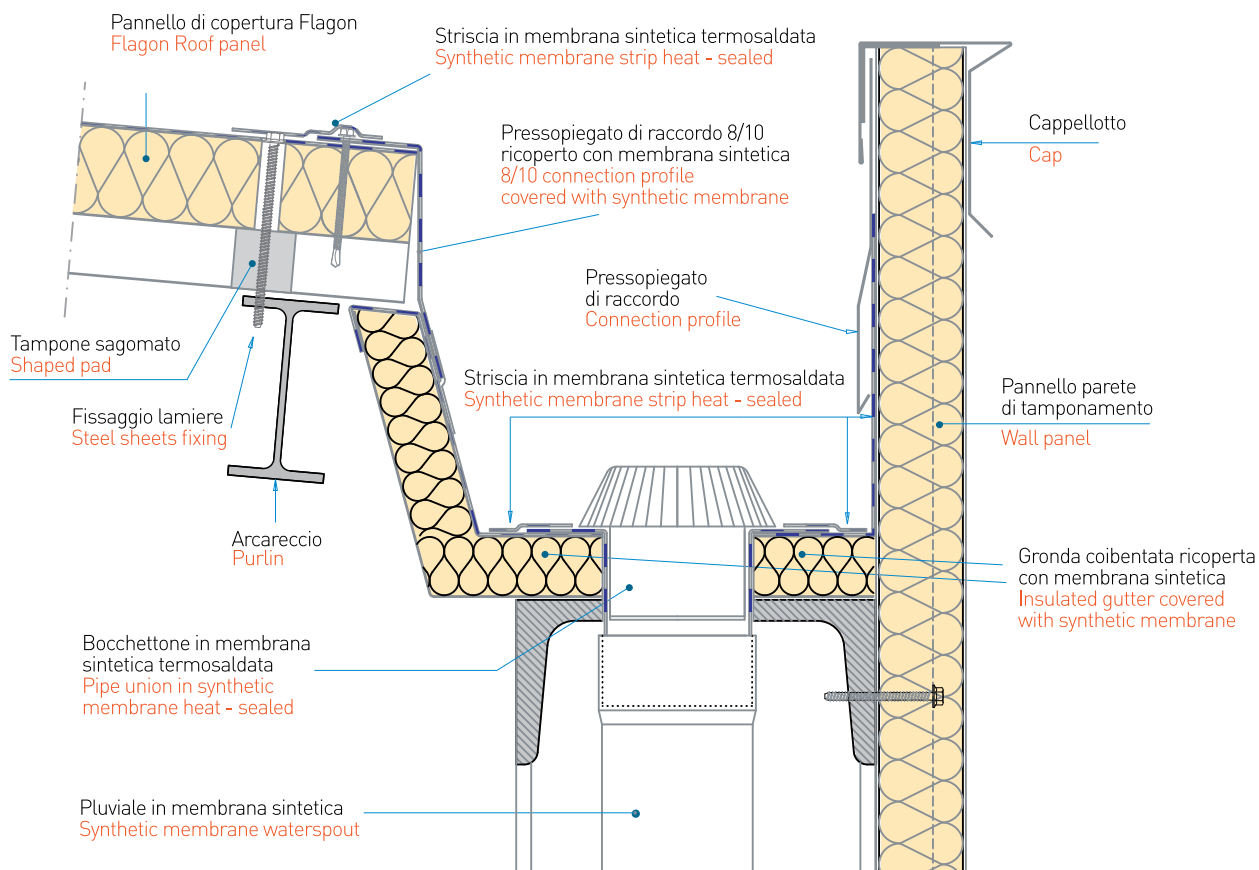

Fissaggio Tipico - Typical fixing

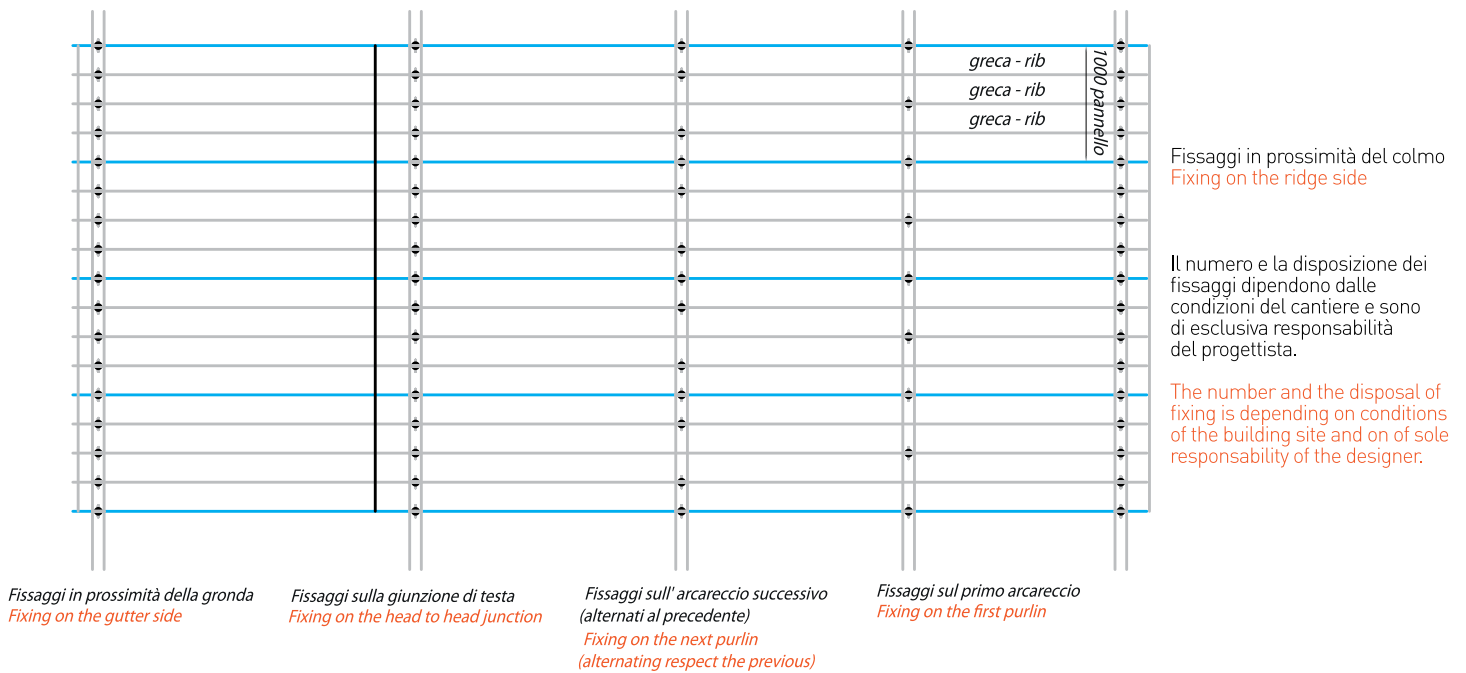

Lucernario su pannello Fagon - Skylight on Flagon roof panel

